

eMotio & eMotio+

ELECTRICAL EXAMINATION COUCH



eMotio+



eMotio



eMotio & eMotio+ INNOVATION FOR PRACTICES

The all-electric eMotio couch is the most efficient examination couch ever designed, with the aim of becoming the new assistant for the general practitioner and specialist. Promotal carried out the largest study ever conducted in medical furniture with 200 doctors from 6 European countries.

The final product, the result of three years development, allows the doctor to fully concentrate on the diagnosis, whilst gaining time and space. The patient benefits from increased comfort and lower stress for a more balanced exchange.



eMotio

*Chair and couch positions
reached with 1 click*

*Variable height
from 45 to 96cm
(105cm with the Tilt)*

*Easy access
around the couch*

High comfort upholstery



WITH **eMotio & eMotio+**, PROMOTAL REINVENTS
THE MEDICAL CONSULTATION AROUND 3 PILLARS :

EQUALITY OF TREATMENT :

- > Welcome and examination in chair position
- > Low position up to **45 cm**
- > **Smooth, safe** electrical motions
- > **More balanced** relationship between the doctor and his patient
- > Folding assistance handles (not compatible with the eMotio+)
- > **High comfort** upholstery
- > Welcomes patients up to **205 kg**

EFFECTIVENESS :

- > Your favourite positions **with one press**: two 100% configurable examination positions, return to welcome position, couch and chair positions
- > Fast, easy **access around the couch**
- > Gyneco position, with possibility of raising the pelvis **up to 105 cm**
(Included for the eMotio+, as an option for the eMotio)

AVAILABLE ACCESSORIES

Models	Convertible arm rests and leg rests	Adjustable headrest	Tilt
eMotio 4050-20	Accessory	Accessory	Option
eMotio+ 4055-20	●	●	●



2 fully configurable Quick Exam positions, that let you select your 2 favourite examination positions with 1 press

eMotio+

Pedal controlled elevation



2-in-1 arm rests and leg rests
ref. 40923



Pair of stirrups
ref. 40850



Pair of base rails
ref. 40878



Lamp bracket
ref. 40950



Folding assistance handles
(not compatible with the eMotio+)
ref. 40922



Adjustable headrest
ref. 11679-01

AVAILABLE OPTIONS



Electrical gyneco tilt
ref. 40300





















Integrated mains supply socket
+ Equipotential terminal
EUROPE, UK, US - ref. 40400-1
DK, IT, AUS, CH - ref. 40400-2

USE ERGONOMICS :

- > Welcome and favourite examination positions reached **with 1 click**
- > **All-electric:** height, effortlessly adjustable backrest and leg rest inclination
- > **Ergonomic controls:** control of elevation and trendelenburg (optional) by pedal and swivelling control panel
- > Low position **up to 45 cm**, high position **up to 96 cm**
- > Electrically activated castors by sustained contact
- > Pediatric & gyneco examination positions

AVAILABLE
COLOURS

32 - BLUE		CLASSIC
93 - COTTAGE		
35 - RED		
34 - YELLOW		
91 - WHITE		
92 - MARINE		
56 - DARKNESS		
57 - ANTISTATIC		VITAMIN
64 - GRAPE		
67 - LAGOON		
66 - SWEET		
63 - CEDRAT		COSY
80 - SKY		
81 - SEA GREEN		
65 - LILAC		
96 - TIN		
82 - MOUSE GREY		
83 - NATURAL		
84 - CHOCOLATE		

eMotio & eMotio+

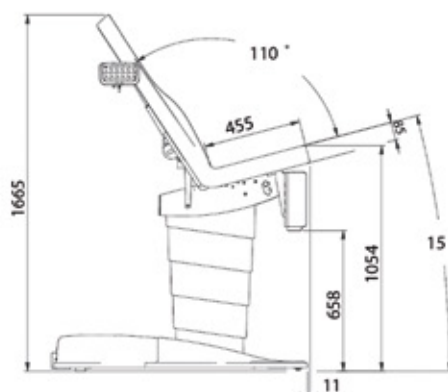
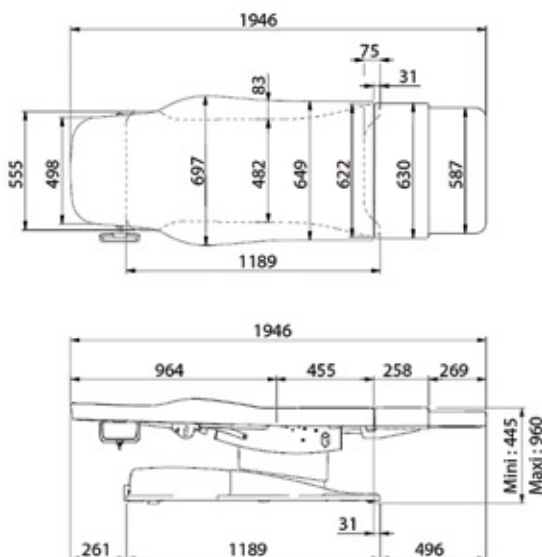

EMOTIO 4050-20

EMOTIO+ 4055-20

GROSS WEIGHT : 175 KG

NET WEIGHT : 138 KG

VOLUME : 0,71 M³



PROMOTAL.COM



22 rue de Saint-Denis-de-Gastines - 53500 Ernée, FRANCE

Phone : + 33 (0)2 43 05 68 95

Fax : + 33 (0)2 43 05 72 00